

Ivedik Organize Sanayi Bölgesi 1453.
Sok. No: 3, 06370 Ostim-Yenimahalle
Ankara / Turkey
• Fax :+90 312 395 57 96
• Tel : +90 312 395 57 95
• Email : export@eryigit.com.tr

Eryiğit
MEDICAL DEVICES

TECHNICAL DATASHEET

STR 2000/2000F



Ivedik Organize Sanayi Bölgesi 1453.
Sok. No: 3, 06370 Ostim-Yenimahalle
Ankara / Turkey
• Fax :+90 312 395 57 96
• Tel : +90 312 395 57 95
• Email : export@eryigit.com.tr

ERYİGIT STR 2000 and 2000F are high quality surgical tables with built-in multiple functions making them available for general surgery and many specialized surgical procedures such as urological, gynecological, cardiovascular, thoracic/kidney, ophthalmic, ENT and neurological.

STR 2000F model differs from STR 2000 model by being equipped with a horizontal sliding function and a backup battery. Both models utilize the same accessories.

Dimensions and Weights

Table top	5 sections
Head Section	250 mm.
Back Section*	500 mm.
Kidney Part (optional)	100 mm.
Seat Section	500 mm.
Leg Section**	640 mm.
Length of table top	2038 mm.
Table Top Width, w side rails	554 mm.
Table Top Width, w/o side rails	500 mm.
Table Weight	330 kg.
Lifting Capacity	Standard (all positions) 350 kg, Max. 400 kg.
Floor Clearance	32 mm.

* Back section can be manufactured as two separate pieces when requested

** Leg section can be manufactured in single piece when requested.

Electrical Characteristics

Mains Supply	230 VAC 50-60 Hz, Single phase
Electrical Protection	Class Ib Device
Charge Indicator*	On Column Wall
Dry Battery*	Quick Charge & Maintenance Free
	27.6 V DC Charging Voltage
	6 Amp/Hour capacity
	Duration of 30 minutes (200 moves)

*only in 2000F model

Ivedik Organize Sanayi Bölgesi 1453.
Sok. No: 3, 06370 Ostim-Yenimahalle
Ankara / Turkey
• Fax :+90 312 395 57 96
• Tel : +90 312 395 57 95
• Email : export@eryigit.com.tr

Adjustment Ranges

Height (Up/Down)*	740 - 1070 mm.
Head Section (up/down) **	90°/ 80°
Back Section (up/down)	80°/ 40°
Leg Section (up/down), gas spring assisted	30°/ 90°
Leg Section Pivoting Split	90°
Flex/Reflex*	230°/ 120°
Trendelenburg / Reverse Trend.*	30°/ 30°
Lateral Tilt (left/right)*	<i>Standard: 20°/ 20°, Optional: 30°/ 30°</i>
Longitudinal Slide*	300 mm.
Kidney Elevator, optional***	lift up to 120 mm.
Thorax Elevation, optional*	lift up to 120 mm.

* Electrohydraulic drive by hand control/column wall control, ** Manually controlled

*** Manual/Electrohydraulic drive

Quality and Standards

Quality Certificates	ISO 9001, ISO 13485, ISO 14001:2004
Standards	EN 60601-1-2; EN 60601-1; TS EN 60601-2-46
Device Classification	Class I acc. to EC MDD 93/42/EEC as amended by directive 2007/47/EC (Annex IX)

Table Pad

Standard

50 mm, Poliurethane, Visco-elastic, Waterproof, Antibacterial, Antistatic

Optional

80 mm, soft, Visco top layer, Standard urethane middle layer, Rubber base, Waterproof, Antibacterial, Antistatic, Set fixed to the table with velcro tapes

Ivedik Organize Sanayi Bölgesi 1453.
Sok. No: 3, 06370 Ostim-Yenimahalle
Ankara / Turkey
• Fax :+90 312 395 57 96
• Tel : +90 312 395 57 95
• Email : export@eryigit.com.tr

General Construction Features

√ Fixed back and seat sections	√ Accessory rails of stainless steel on both sides (safety catch opt.)
√ Detachable leg and head sections	√ Swivelling four castors, device locking pedal
√ Top plate of X-ray translucent high pressure compact laminate	√ Smooth and silent electrohydraulic drive (no sound, no vibration)
√ X-ray cassette rails along the full length of the surgical area	√ AISI 304 Stainless Steel base and column panels



Ivedik Organize Sanayi Bölgesi 1453.
Sok. No: 3, 06370 Ostim-Yenimahalle
Ankara / Turkey
• Fax :+90 312 395 57 96
• Tel : +90 312 395 57 95
• Email : export@eryigit.com.tr

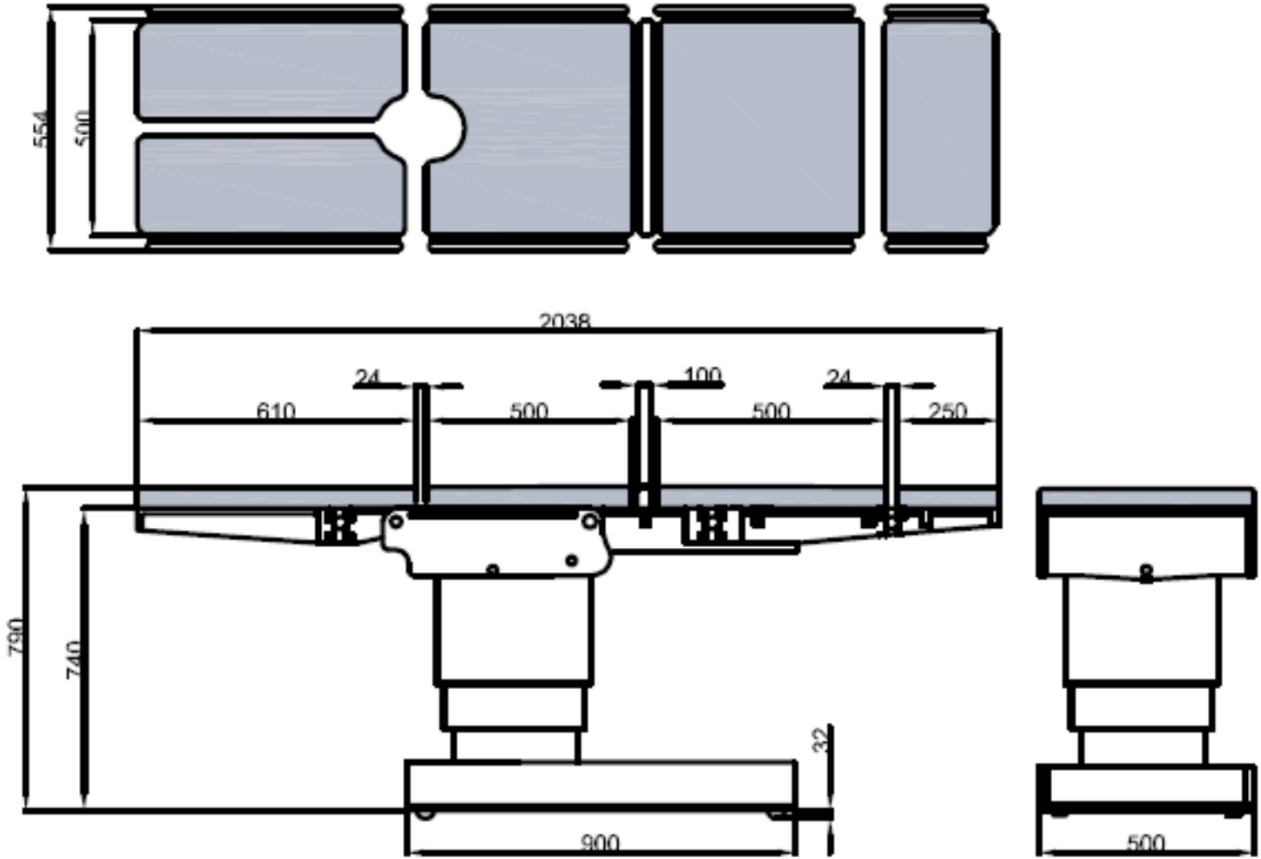

The functional design and easy-to-use hydraulic and electrohydraulic adjustments assure efficient and unobstructed working access for the surgical team. A selection of practical accessories also makes the STR 2000 and 2000F surgical tables available for the most demanding procedures.

Positions of the STR Operation Table

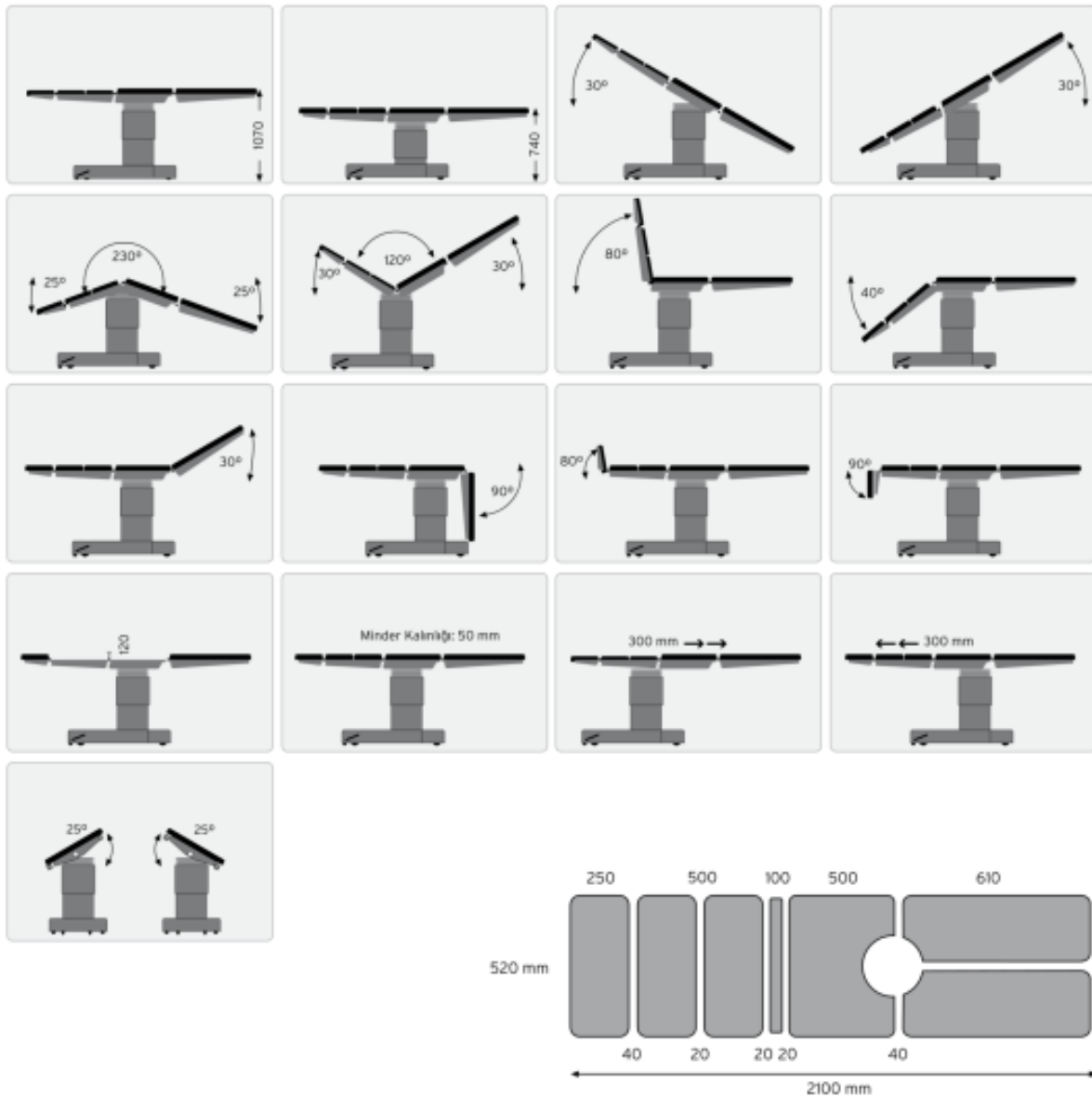

Ivedik Organize Sanayi Bölgesi 1453.
 Sok. No: 3, 06370 Ostim-Yenimahalle
 Ankara / Turkey

- Fax : +90 312 395 57 96
- Tel : +90 312 395 57 95
- Email : export@eryigit.com.tr

Available Positions for Surgical Operations

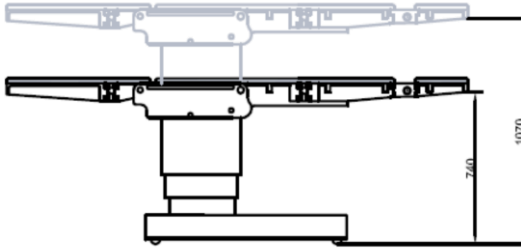

HEIGHT

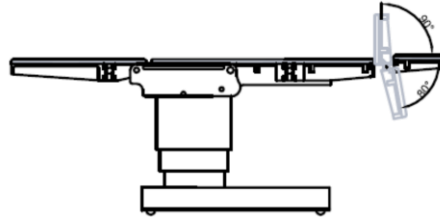

LEG and HEAD SECTION

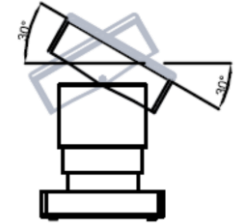

LATERAL TILT

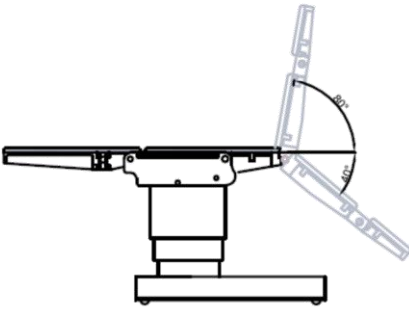

BACK SECTION

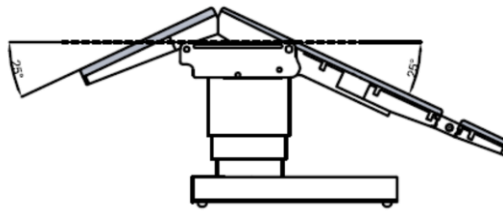

FLEX

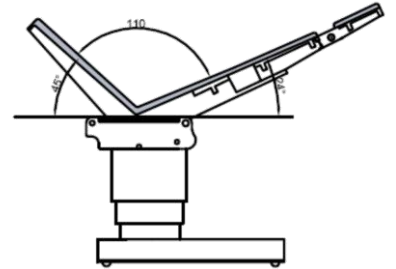

REFLEX

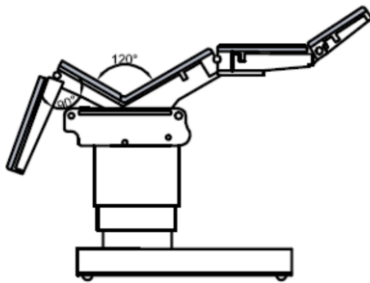

THORAX

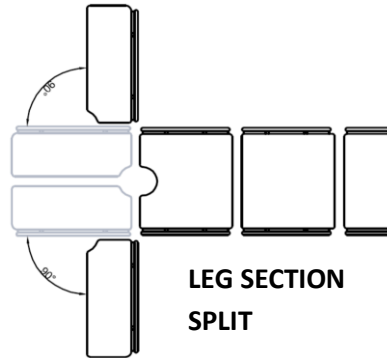

LEG SECTION SPLIT

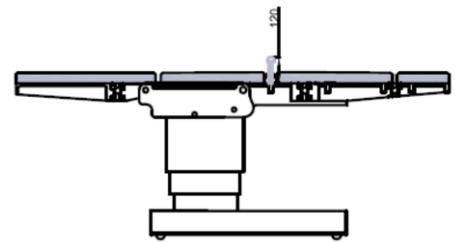

KIDNEY ELEVATOR

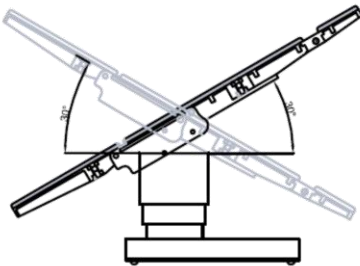

TREND. / REVERSE TREND.

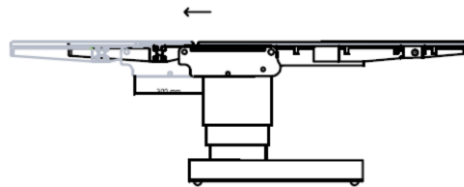

LONGITUDINAL SLIDE

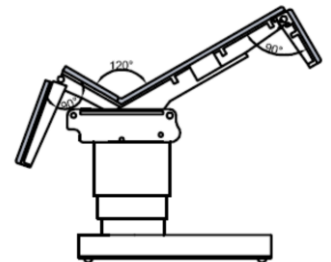

















CHAIR

Ivedik Organize Sanayi Bölgesi 1453.
 Sok. No: 3, 06370 Ostim-Yenimahalle
 Ankara / Turkey

- Fax :+90 312 395 57 96
- Tel : +90 312 395 57 95
- Email : export@eryigit.com.tr

ICONS OF HAND CONTROL UNIT AND CONTROL UNIT ON BODY

Table Up / Down	 	Back Section Up/ Down	 	
Trendelenburg Reverse Trendel.	 	Sliding Forward/ Backward	 	
On / Off		Zero Position (Level)		
Lateral Right / Left	 			
Flex / Reflex	 			
Floor Unlock / Lock	 			



Ivedik Organize Sanayi Bölgesi 1453.
Sok. No: 3, 06370 Ostim-Yenimahalle
Ankara / Turkey
• Fax :+90 312 395 57 96
• Tel : +90 312 395 57 95
• Email : export@eryigit.com.tr

Standard Supplied Accessories

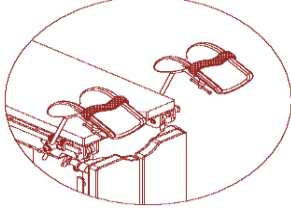

**Leg Crutch/
Knee support
(1 pair)**

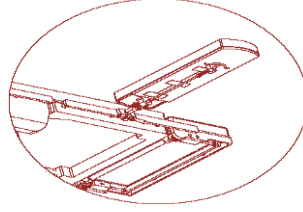

**Arm Board
(1 pair)**



Waste Bowl

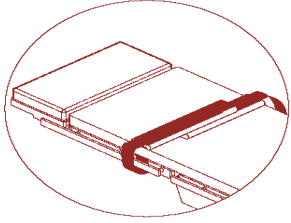

Body Strap

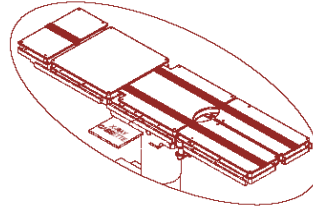

**X-ray Proof
Top**

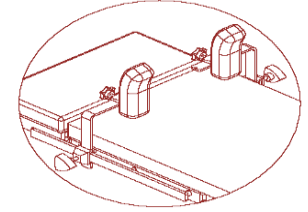

**Shoulder Support
(1 pair)**

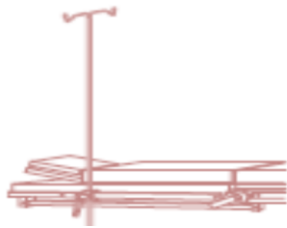

Serum Stand

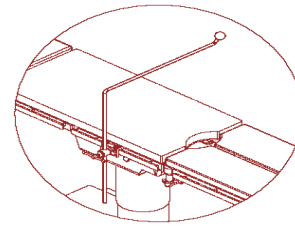

Anesthesia Frame

Optional Accessories

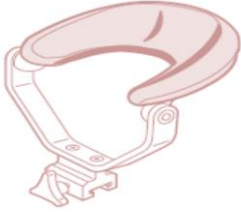

U-type Head Rest



Silicone Head Rest

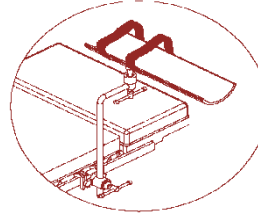

Raised arm

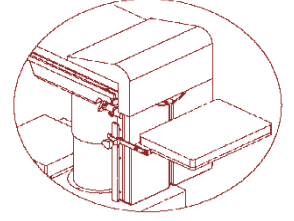

Rectal Positioning Support

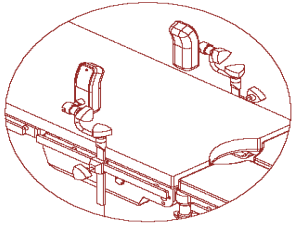

Lateral Support

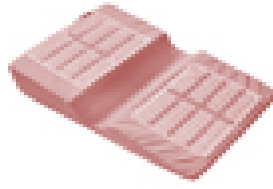

Silicone Body Support

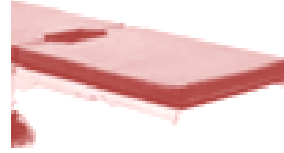

Single Piece Leg Plate

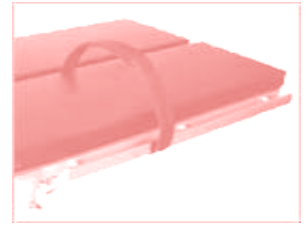

Leg Strap

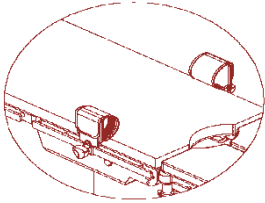

Wrist Strap

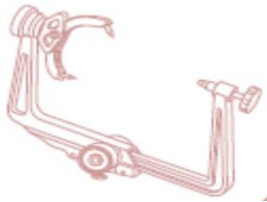

Skull Clamp



Crossbar adapter Skull Clamp



X-ray film cassette holder

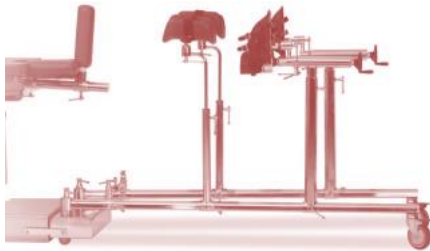

Orthopedic Traction Set

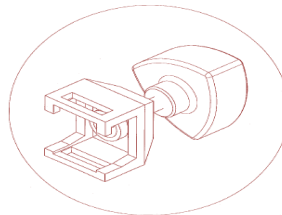

Side Rail Lock

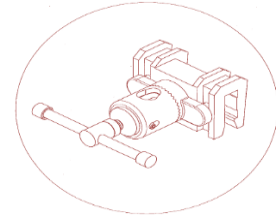

Side Rail Clamp